

---

**32013 Technic Angle Connector #1**



---

**32034 Technic Angle Connector #2**



---

**32016 Technic Angle Connector #3**



---

**924 Technic Angle Connector #4**

LDraw File: [\[924.DAT\]](#)

Peeron: [Technic Angle Connector #4](#)



---

**32015 Technic Angle Connector #5**

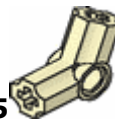

---

**32014 Technic Angle Connector #6**

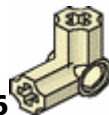

---

**3704 Technic Axle 2**



---

**32062 Technic Axle 2 Notched**



---

**4519 Technic Axle 3**



---

**6587 Technic Axle 3 with Stud**



---

**3705 Technic Axle 4**

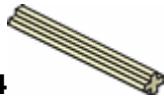

---

**3705c01 Technic Axle 4 Threaded**



---

**32073 Technic Axle 5**

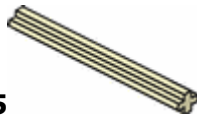

---

**552 Technic Axle 5.5 With Stop**

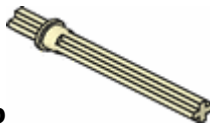

---

**3706 Technic Axle 6**

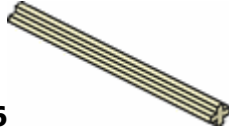

---

**3707 Technic Axle 8**

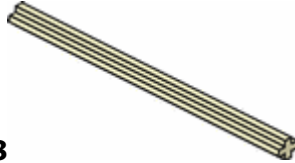

---

**3737 Technic Axle 10**

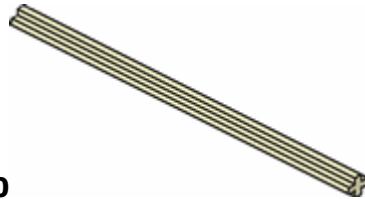

---

**3737c01 Technic Axle 10 Threaded**



---

**3708 Technic Axle 12**

---

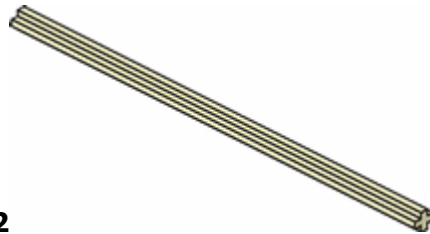

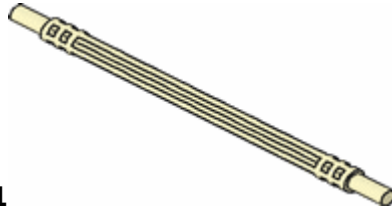

**32199 Technic Axle Flexible 11**

---

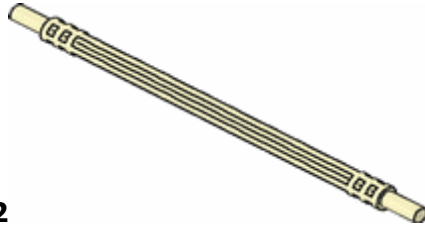

**32200 Technic Axle Flexible 12**

---

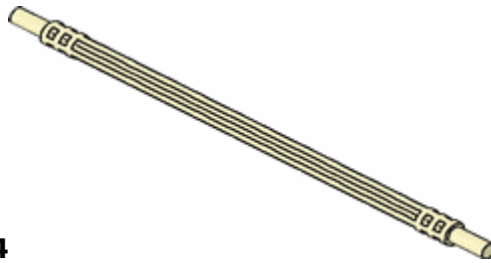

**32201 Technic Axle Flexible 14**

---

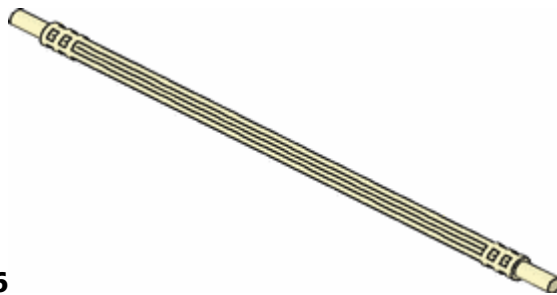

**32202 Technic Axle Flexible 16**

---

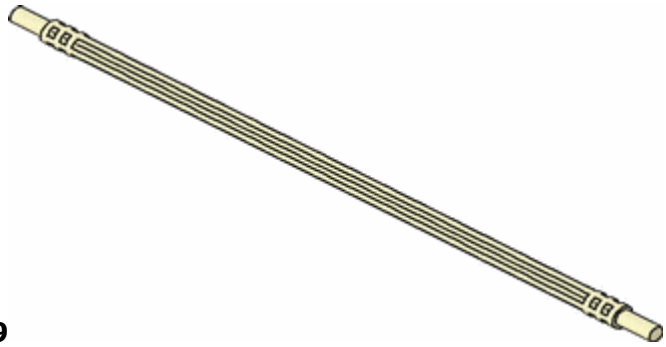

**32235 Technic Axle Flexible 19**

---



**6538 Technic Axle Joiner**

---



**6536 Technic Axle Joiner Perpendicular**

---



**32184 Technic Axle Joiner Perpendicular 3L**

---



**32068 Technic Axle Joiner Perpendicular 3 Long**

---



**32291 Technic Axle Joiner Perpendicular Double**

---

**4698 Technic Axle Nut** 

---

**3749 Technic Axle Pin** 

---

**2736 Technic Axle Towball** 

---

**2907 Technic Ball with Grooves** 

---

**2989 Technic Brick 1 x 4 with Holes and Bumper Holder** 

---

**6541 Technic Brick 1 x 1 with Hole** 

---

**32064 Technic Brick 1 x 2 with Axlehole** 

---

**3700 Technic Brick 1 x 2 with Hole** 

---

**32000 Technic Brick 1 x 2 with Holes**

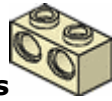

---

**3701 Technic Brick 1 x 4 with Holes**

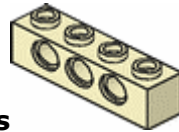

---

**3894 Technic Brick 1 x 6 with Holes**

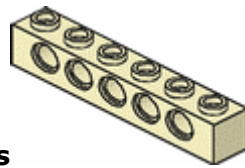

---

**3702 Technic Brick 1 x 8 with Holes**

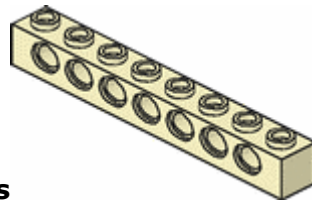

---

**2730 Technic Brick 1 x 10 with Holes**

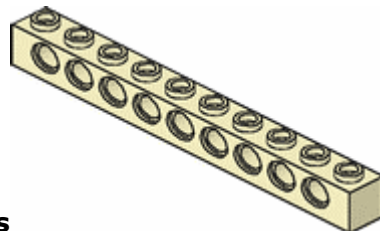

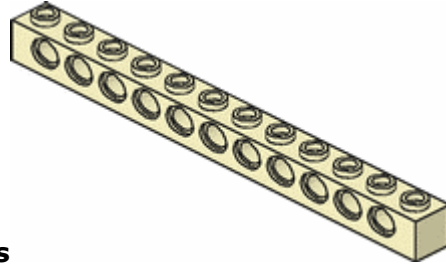

**3895 Technic Brick 1 x 12 with Holes**

---

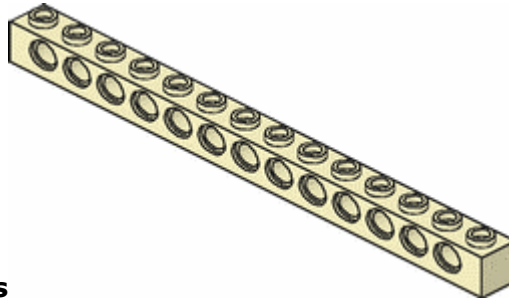

**32018 Technic Brick 1 x 14 with Holes**

---

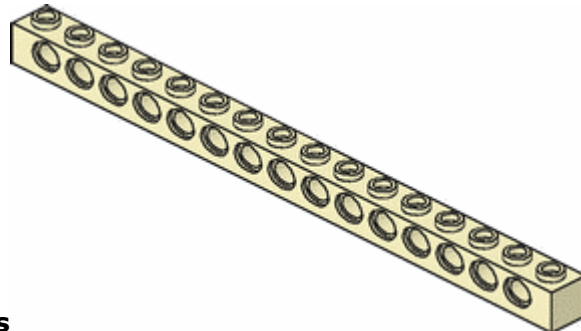

**3703 Technic Brick 1 x 16 with Holes**

---

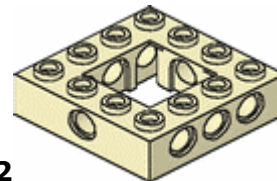

**32324 Technic Brick 4 x 4 with Open Center 2 x 2**

---



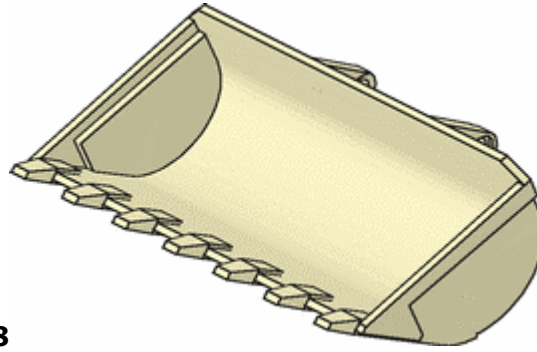

**2951 Technic Bucket 10 x 8**

---

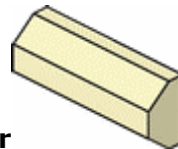

**70961 Technic Bumper 2 x 4 Rubber**

---



**3713 Technic Bush**

---



**4265c Technic Bush 1/2 Smooth**

---



**4265a Technic Bush 1/2 Type I**

---



**4265b Technic Bush 1/2 Type II**

---



**6575 Technic Cam**

---

**3651 Technic Connector**



---

**133 Technic Connector 2 x 3 with Ball Socket**



---

**32137 Technic Connector Block 3 x 2 x 2**



---

**111 Technic Connector Block 3 x 3 Triangular**

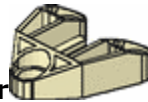

---

**32310 Technic Connector Block 3 x 5 x 1 & 2/3**



---

**32165 Technic Connector Block 3 x 6 x 1 & 2/3**

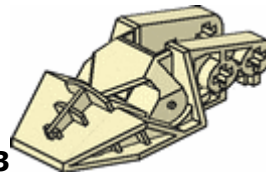

---

**32166 Technic Connector Block 3 x 6 x 1 & 2/3 Gearbox**

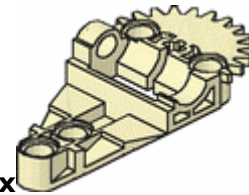

---

**44 Technic Connector Toggle Joint Smooth**



---

**4273 Technic Connector Toggle Joint Toothed**



---

**32039 Technic Connector with Axlehole**



---

**73071 Technic Differential**

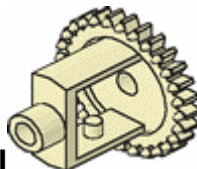

---

**6573 Technic Differential New**

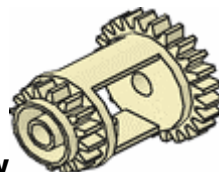

**2958 Technic Disc 3 x 3 with Axlehole**



---

**2852 Technic Engine Connecting Rod**



---

**2853 Technic Engine Crankshaft**



---

**2854 Technic Engine Crankshaft Centre**



---

**2850 Technic Engine Cylinder Head**

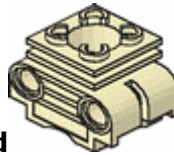

---

**2851 Technic Engine Piston Round**



---

**75 Technic Flex-System Hose 120LDU Long (open file for usage guide)**



---

**2823 Technic Forklift Fork**

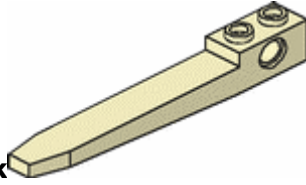

---

**50 Technic Friction Peg with Towball**



---

**3647 Technic Gear 8 Tooth**



---

**6589 Technic Gear 12 Tooth Bevel**



---

**32270 Technic Gear 12 Tooth Double Bevel**



---

**741 Technic Gear 14 Tooth**



---

**4143 Technic Gear 14 Tooth Bevel**



---

**4019 Technic Gear 16 Tooth**



---

**6542 Technic Gear 16 Tooth with Clutch**



---

**32198 Technic Gear 20 Tooth Bevel**



---

**32296 Technic Gear 20 Tooth Double Bevel**



---

**742 Technic Gear 21 Tooth**

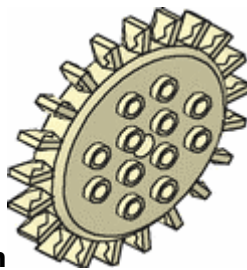

---

**3648 Technic Gear 24 Tooth**



---

**3648a Technic Gear 24 Tooth**



---

**60c01 Technic Gear 24 Tooth Clutch**

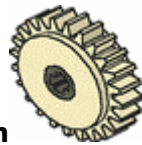

---

**3650a Technic Gear 24 Tooth Crown**



---

**743 Technic Gear 35 Tooth**

---

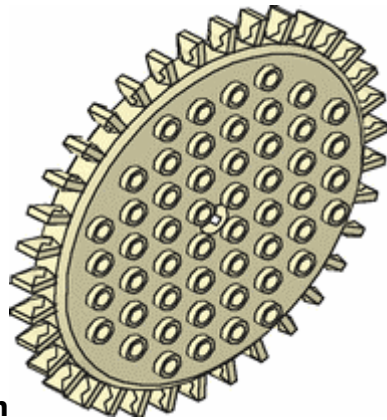

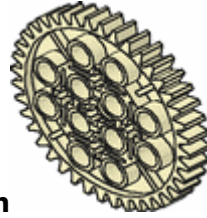

**3649 Technic Gear 40 Tooth**

---

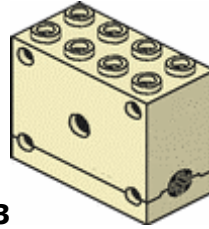

**768 Technic Gear Block 2 x 8 x 3**

---

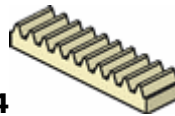

**3743 Technic Gear Rack 1 x 4**

---

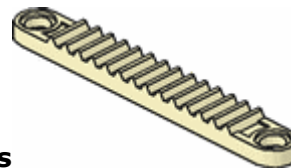

**6630 Technic Gear Rack 1 x 8 with Holes**

---

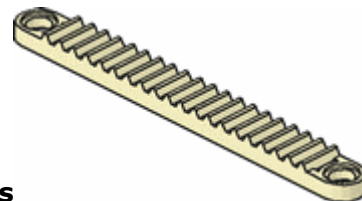

**6592 Technic Gear Rack 1 x 10 with Holes**

---



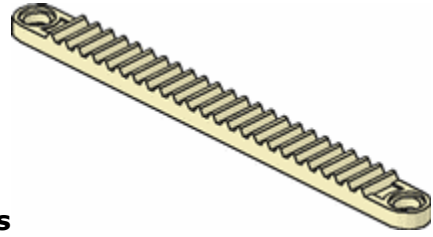

**32132 Technic Gear Rack 1 x 12 with Holes**

---

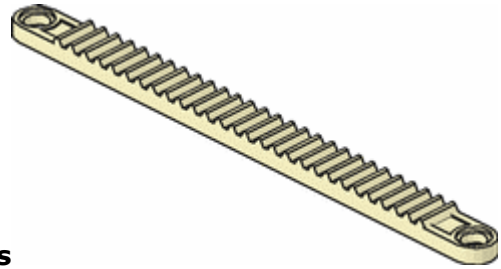

**32185 Technic Gear Rack 1 x 14 with Holes**

---

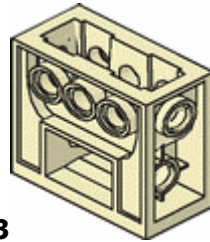

**6588 Technic Gearbox 2 x 4 x 3 & 1/3**

---



**424 Technic Handle**

---



**2908 Technic Helicopter Rotor Holder**

---



**30 Technic Hook Large Metallic**

---



**2741 Technic Large Steering Wheel**

---

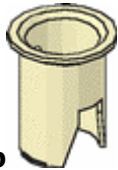

**2999 Technic Large Wheel Hub**

---



**6632 Technic Liftarm 1 x 3**

---



**32523 Technic Liftarm 1 x 3 Straight**

---



**2825 Technic Liftarm 1 x 4**

---

**32017 Technic Liftarm 1 x 5**



**32316 Technic Liftarm 1 x 5 Straight**

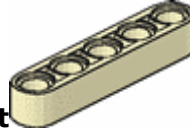

**32063 Technic Liftarm 1 x 6**

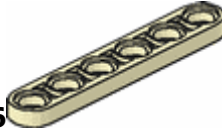

**32065 Technic Liftarm 1 x 7**

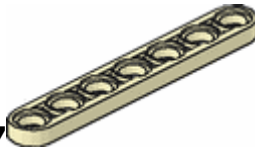

**32348 Technic Liftarm 1 x 7 Bent**

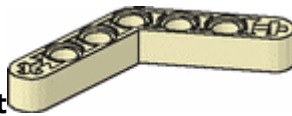

**152 Technic Liftarm 1 x 9 Bent**

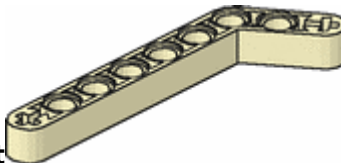

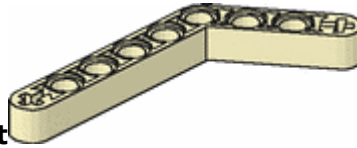

**6629 Technic Liftarm 1 x 9 Bent**

---

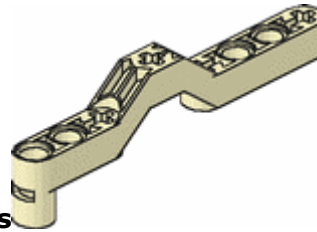

**32079 Technic Liftarm 1 x 9 Offset Cross**

---

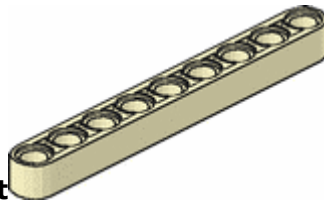

**120 Technic Liftarm 1 x 9 Straight**

---

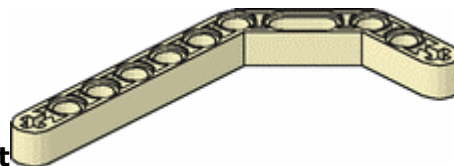

**32009 Technic Liftarm 1 x 11.5 Double Bent**

---

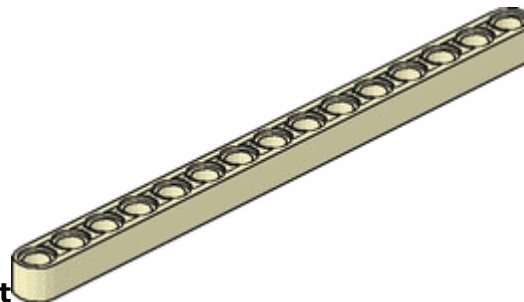

**32278 Technic Liftarm 1 x 15 Straight**

---

**32140 Technic Liftarm 2 x 4 L Shape**

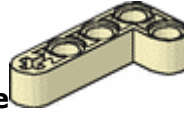

---

**32056 Technic Liftarm 3 x 3 L Shape**



---

**32249 Technic Liftarm 3 x 3 L Shape with Quarter Circle**



---

**153 Technic Liftarm 3 x 5 L Shape**

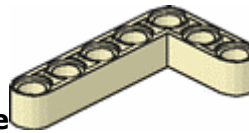

---

**32250 Technic Liftarm 3 x 5 L Shape with Quarter Oval**

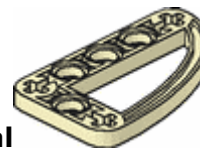

---

**32173 Technic Liftarm 2 x 7 with 2 Ball Joints**

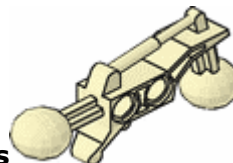

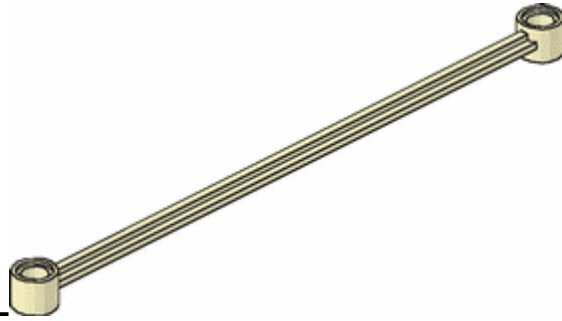

**2637 Technic Link 16L**

---



**3711 Technic Link Chain**

---



**3873 Technic Link Tread**

---

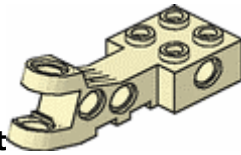

**2904 Technic Motorcycle Pivot**

---

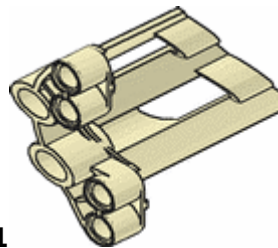

**22749 Technic Panel Fairing #1**

---

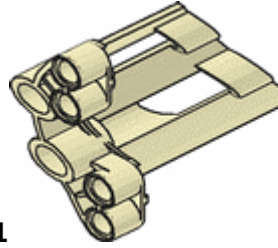

**32190 Technic Panel Fairing #1**

---

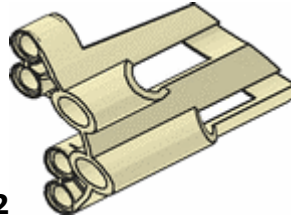

**22750 Technic Panel Fairing #2**

---

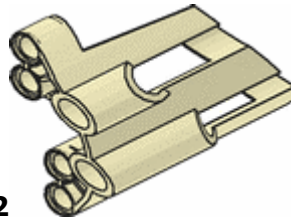

**32191 Technic Panel Fairing #2**

---

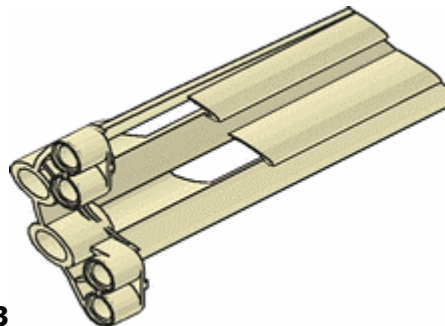

**22972 Technic Panel Fairing #3**

---

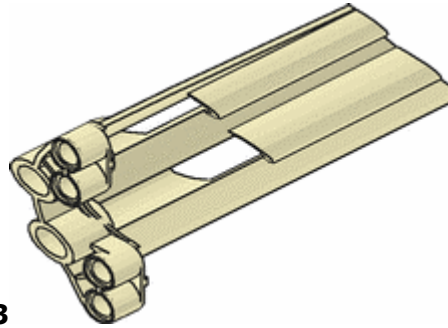

**32188 Technic Panel Fairing #3**

---

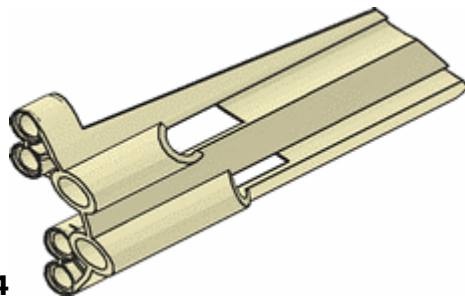

**22973 Technic Panel Fairing #4**

---

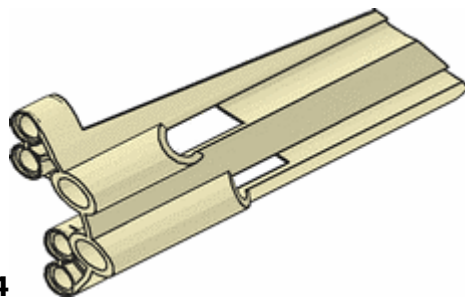

**32189 Technic Panel Fairing #4**

---

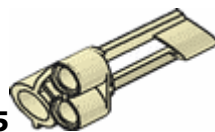

**32527 Technic Panel Fairing #5**

---



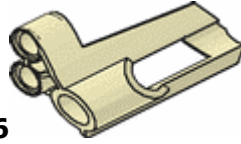

**32528 Technic Panel Fairing #6**

---

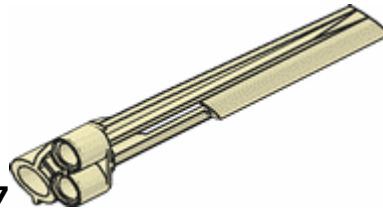

**32534 Technic Panel Fairing #7**

---

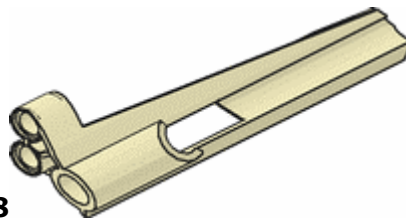

**32535 Technic Panel Fairing #8**

---



**3673 Technic Pin**

---

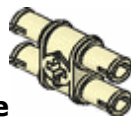

**32136 Technic Pin 3L Double**

---



**4274 Technic Pin 1/2**

---

**32002 Technic Pin 3/4**



---

**32557 Technic Pin Joiner Dual Perpendicular**



---

**75535 Technic Pin Joiner Round**



---

**6558 Technic Pin Long with Friction**



---

**32054 Technic Pin Long with Stop Bush**



---

**4459 Technic Pin with Friction**



---

**2780 Technic Pin with Friction and Slots**



---

**4263 Technic Plate 1 x 4 with Holes**



---

**4262 Technic Plate 1 x 6 with Holes**

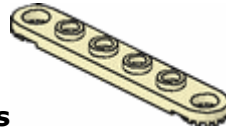

---

**4442 Technic Plate 1 x 8 with Holes**

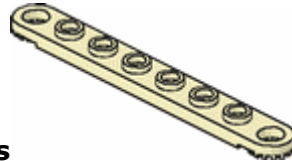

---

**2719 Technic Plate 1 x 10 with Holes**

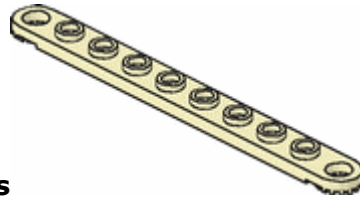

---

**3709b Technic Plate 2 x 4 with Holes**

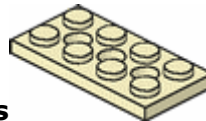

---

**32001 Technic Plate 2 x 6 with Holes**

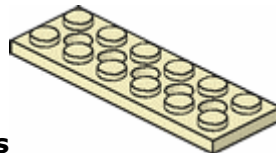

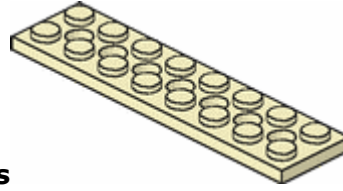

**3738 Technic Plate 2 x 8 with Holes**

---

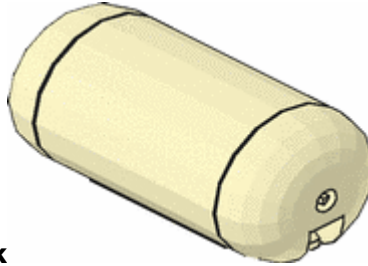

**67c01 Technic Pneumatic Airtank**

---



**6553 Technic Pole Reverser Handle**

---



**3736 Technic Pulley Large**

---



**78 Technic Ribbed Hose 120LDU Long (open file for usage guide)**

---



**2712 Technic Rotor 3 Blade**

---

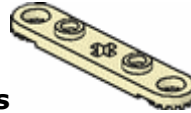

**2711 Technic Rotor 2 Blade with 2 Studs**

---

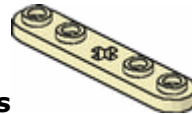

**32124 Technic Rotor 2 Blade with 4 Studs**

---



**32125 Technic Rotor 3 Blade with 6 Studs**

---

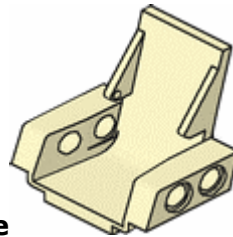

**2717 Technic Seat 3 x 2 Base**

---



**732 Technic Shock Absorber 6.5L, Cylinder**

---



**731 Technic Shock Absorber 6.5L, Piston Rod with Spring**

---

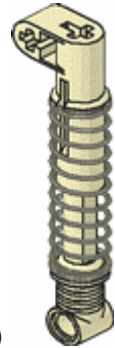

**2909c01 Technic Shock Absorber 9.5L, (Complete Assembly Shortcut)**

---

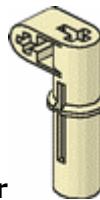

**2909 Technic Shock Absorber 9.5L, Cylinder**

---



**109 Technic Shock Absorber 9.5L, Piston Rod**

---

**110 Technic Shock Absorber 9.5L, Spring**



**32181c02 Technic Shock Absorber 10L Damped, (Complete Assembly Shortcut)**



**32181 Technic Shock Absorber 10L Damped, Cylinder**



**32182 Technic Shock Absorber 10L Damped, Cylinder Cap**



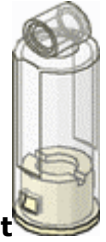

**32181c01 Technic Shock Absorber 10L Damped, Cylinder with Cap Shortcut**

---



**32040 Technic Shock Absorber 10L Damped, Gasket**

---

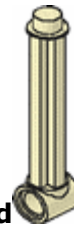

**32183 Technic Shock Absorber 10L Damped, Piston Rod**

---



**32183c01 Technic Shock Absorber 10L Damped, Piston Rod w/ Gasket Shortcut**

---



**108 Technic Shock Absorber 10L Damped, Spring**

---



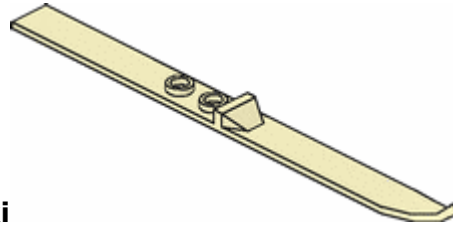

**2713 Technic Ski**

---

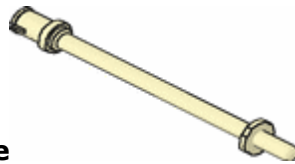

**2714 Technic Ski Pole**

---

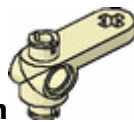

**4261 Technic Steering Arm**

---



**6540 Technic Steering Arm Large**

---

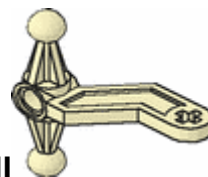

**2737 Technic Steering Arm Tall**

---



**32069 Technic Steering Arm with Connectors**

---

**2790 Technic Steering Gear Holder**



---

**2739 Technic Steering Link**

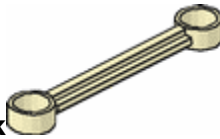

---

**2791 Technic Steering Rack**



---

**2792 Technic Steering Top**

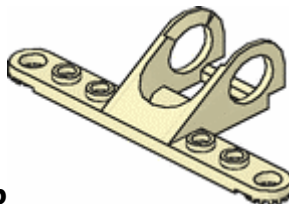

---

**2819 Technic Steering Wheel Small**



---

**6641 Technic Transmission Changeover Catch**



---

**6631 Technic Transmission Changeover Plate 2 x 6**

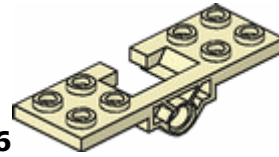

---

**6539 Technic Transmission Driving Ring**



---

**32187 Technic Transmission Driving Ring Extension**



---

**680c01 Technic Tread (Complete Shortcut)**

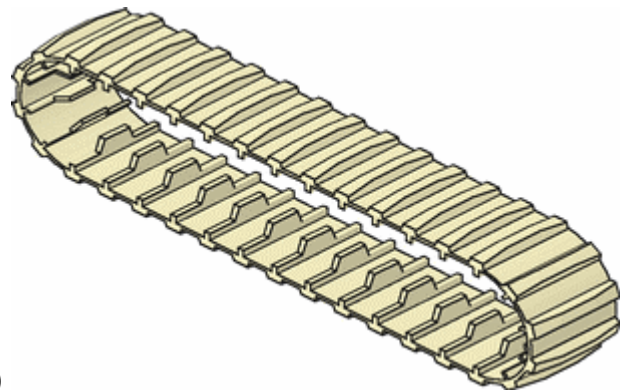

---

**682 Technic Tread Segment Curved**



**680 Technic Tread Segment Straight**



**681 Technic Tread Segment Transition**



**32007 Technic Tread Sprocket Wheel**

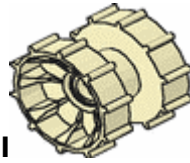

**2905 Technic Triangle**

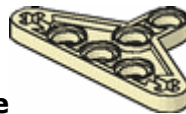

**2856 Technic Turntable Base**

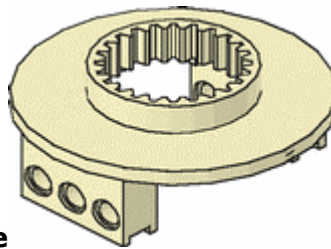

**2855 Technic Turntable Top**

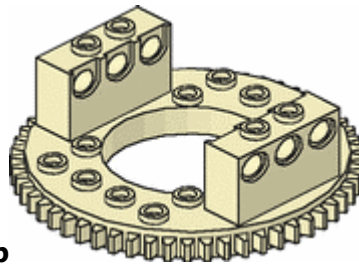

---

**9244 Technic Universal Joint (Complete Assembly Shortcut)**



---

**91 Technic Universal Joint Centre**



---

**90 Technic Universal Joint End**



---

**4185 Technic Wedge Belt Wheel**



---

**70162 Technic Wedge Belt Wheel Tyre**



---

**2744 Technic Wing Back**

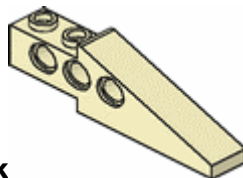

**2743 Technic Wing Front**

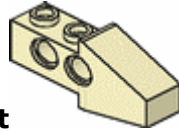

---

**4716 Technic Worm Screw**

